



SPORTS FIELD



HIGH MAST LIGHT



FACTORY



ARCHITECTURAL LIGHTING



**CO-T400B-60W**

9,600LM

24PCS LED



**CO-T400B-120W**

19,200LM

48PCS LED



### CO-T400B-180W

28,800LM

72CS LED

### CO-T400B-240W

38,400LM

96PCS LED

### CO-T400B-360W

57,600LM

144PCS LED

#### Parameter

➤ WATTAGE	60/120/180/240/360W
➤ LIGHT SOURCE	LUMILEDS
➤ LED QUANTITY	24 LEDS EACH MODULE
➤ DRIVER	MEANWELL
➤ LAMP LUMINOUS FLUX	160LM/W±5%(60°/90°/120°)
	150LM/W±5%(15°/30°)
➤ CRI	Ra>70
➤ CCT	2700-6500K
➤ RATED VOLTAGE	AC 90-305V, 50/60Hz

## Features



1 Interchangeable Optical Lenses



2 360° Rotatable Holder

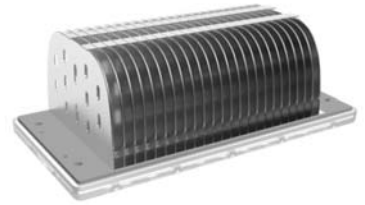

3 High Efficient Heatsink

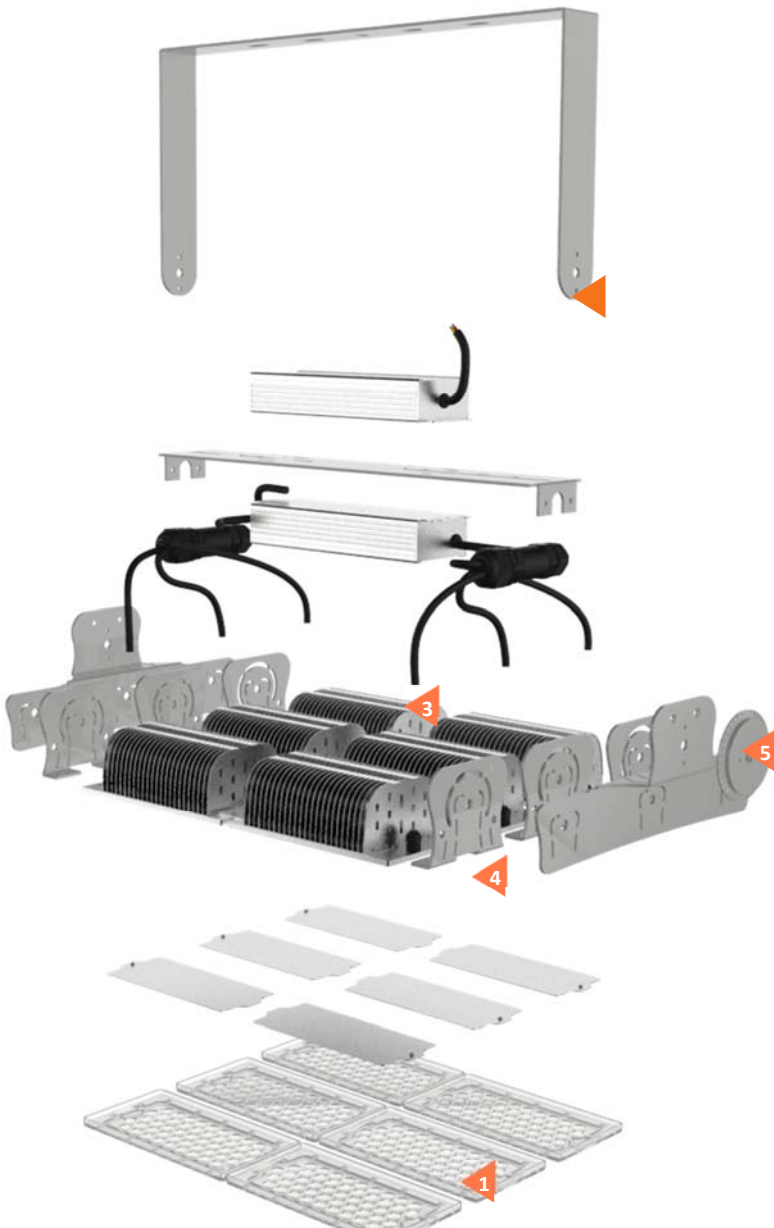

4 Laser Scale Design



5 Original Angle Scale Plate

## Professional Light Distribution

Multiple optical lens choices are available with angles including 15° / 30° / 60° / 90° / 120° to meet the requirements for professional light distribution and an extensive scope of applications.

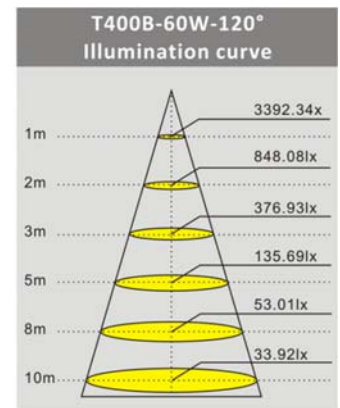
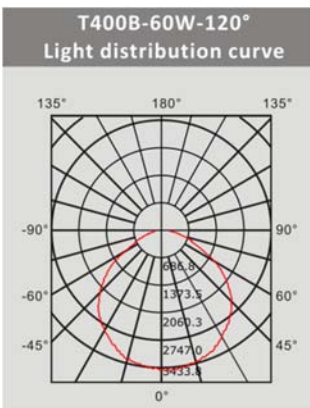
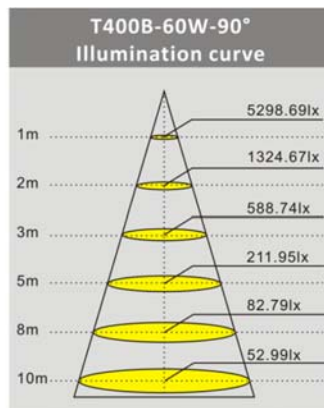
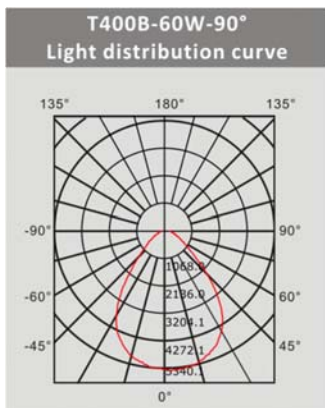
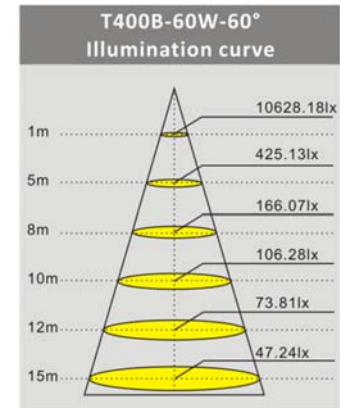
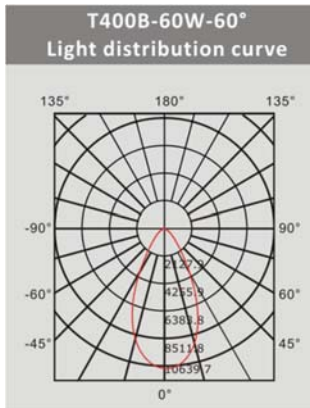
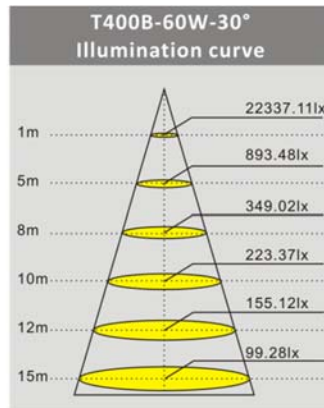
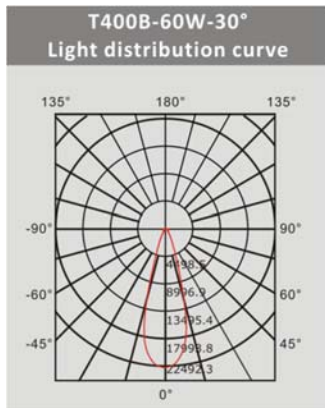
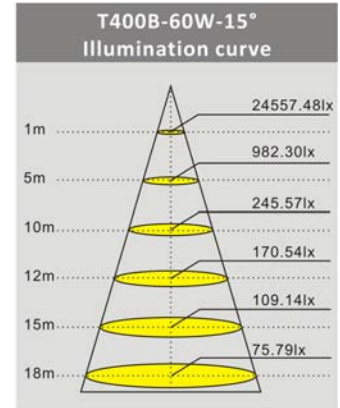
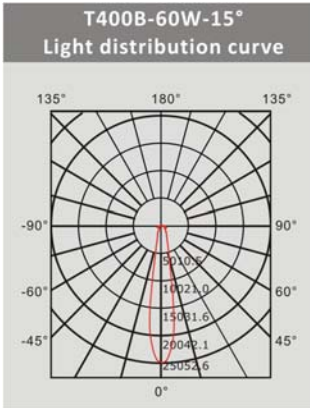

## Temperature Rise Test (CO-T400B-60W)

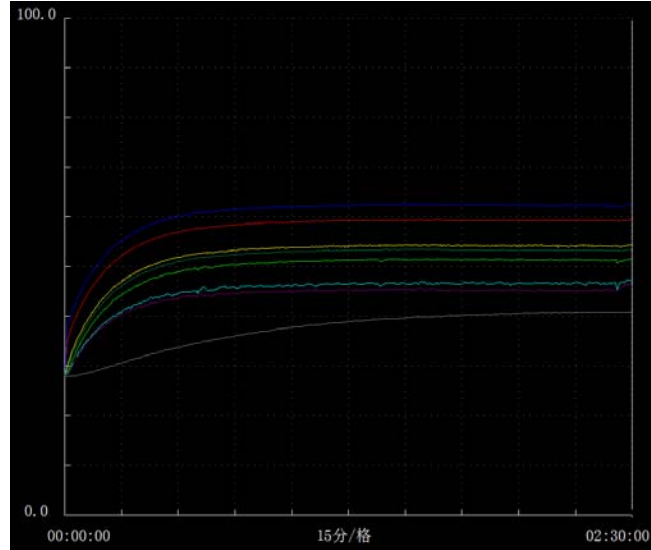
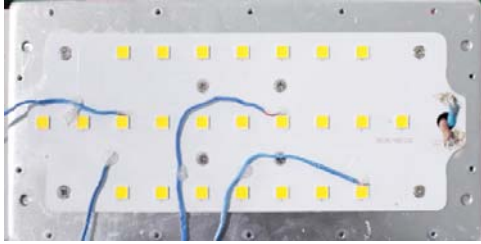

Test Point	Time(min)	00:00:00	00:30:00	01:00:00	01:30:00	02:00:00	02:30:00
CH1 LED		33	58.7	59.6	60	60	60.2
CH2 LED		29.3	53	53.8	54.1	54.2	54.2
CH3 LED		34.6	62.5	63.1	63.3	63.4	63.4
CH4 PCB Board		29.4	53.9	54.6	54.8	54.9	54.8
CH5 Heat sink		28.7	50.7	51.5	51.9	52.1	52.1
CH6 Heat sink		28.3	46.1	46.7	47.1	47.5	47.5
CH7 Heat sink		28.5	45.4	46	46.3	46.5	46.2
CH8 LED Driver		27.8	37.3	40.8	41.9	42.2	42.1

## System test report (CO-T400B-120W 5000K)

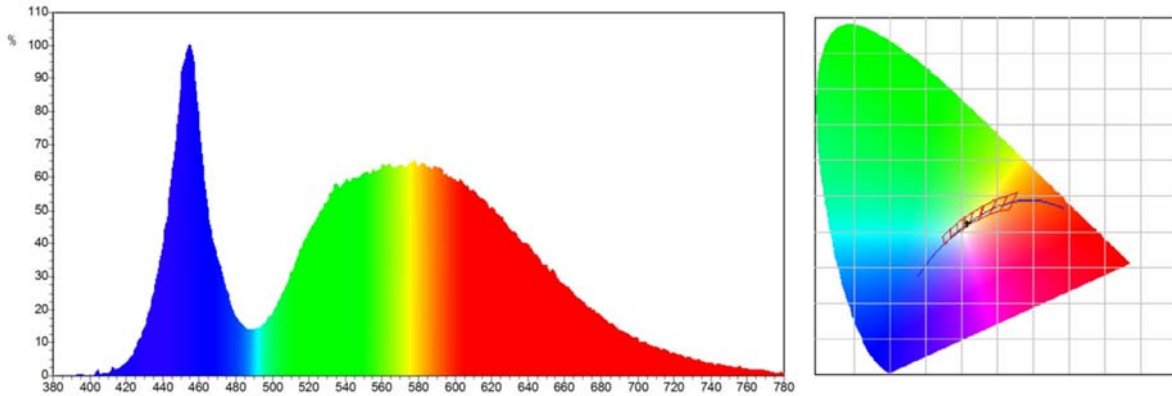

### Electrical parameters

Flux: 19026.2116lm

P: 158.684 lm/w

P: 33402.36 mw

I: 570.0 mA

V: 215.10 V

P: 119.900 w

PF: 0.9730

## Test

### UV Aging Test

The test time is about 1440 hours. After test the lamp working regularly, no discoloration appearance, no yellowing of the pc lens, no rust of the support.



### Waterproof Test

Every lamp will be tested the water-proof at least 2 hours before shipment. The semiautomatic test line make it very efficient to shorten lead time.



## Salt Spray Test

The heat sink processed by oxidization and powder spraying so that it has good corrosion resistance.



## High-Low Temperature Testing

The Test equipment opening 2hours, keeping temperature <math>-40^{\circ}\text{C}</math>, the lamp working fine.

The Test equipment opening 4hours, keeping



## Dimension

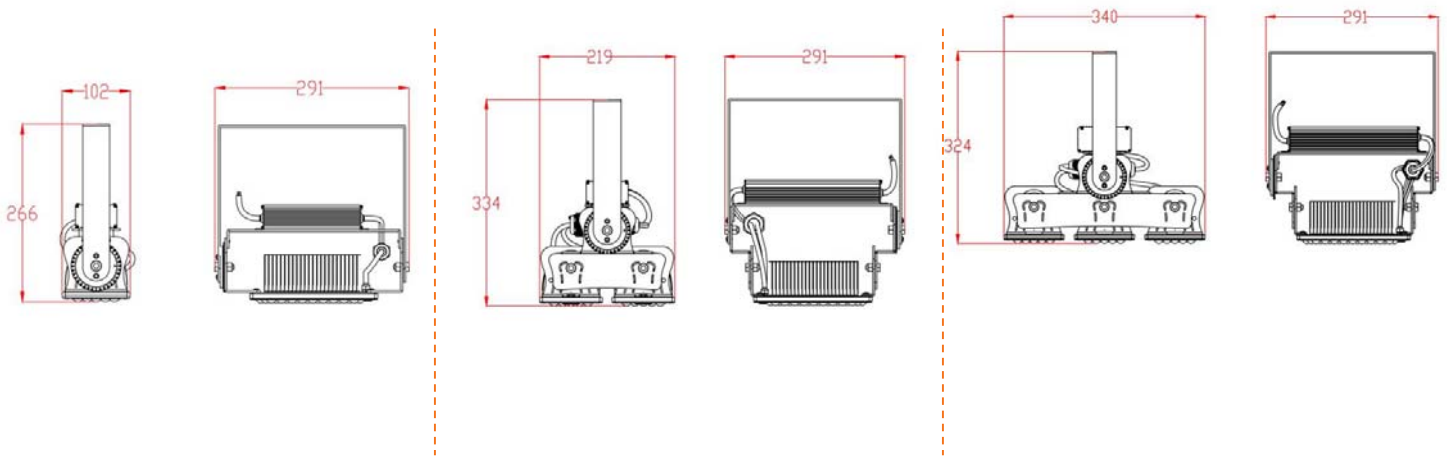

T400B-60W

T400B-120W

T400B-180W



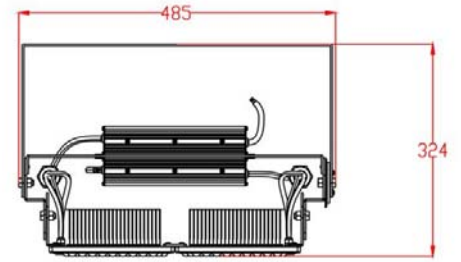
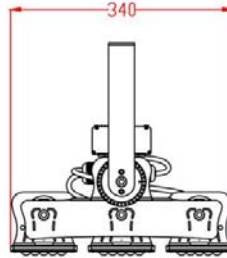
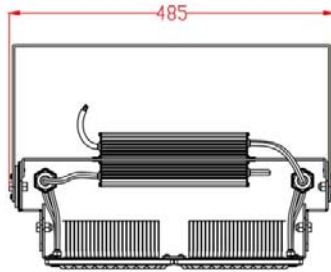
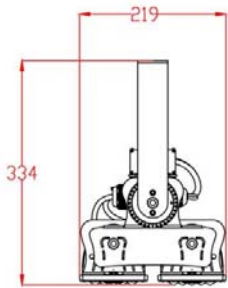

**T400B-240W**

**T400B-360W**

### Packing

Model	Size of Box	Weight of Box	Size of Carton	Gross Weight of Carton	Box PCS /Carton
CO-T400B-60W	33.5*14*30.5cm	2.8KG	72*35.5*63cm	29KG	10
CO-T400B-120W	32*25.5*35.5cm	4.7KG	53*34*73cm	19.8KG	4
CO-T400B-180W	41*33.5*24cm	5.7KG	70*43*50cm	23.8KG	4
CO-T400B-240W	52.5*25.5*34cm	6.9KG	54.5*53*36cm	14.5KG	2
CO-T400B-360W	54*41*24.5cm	9.9KG	56*43*51cm	20.6KG	2